

2014

Electrical Characterization of Deuterium-Doped Gallium Antimonide Grown on Silicon Substrates

Justin T. Dao
University of Vermont

Follow this and additional works at: <https://scholarworks.uvm.edu/hcoltheses>

Recommended Citation

Dao, Justin T., "Electrical Characterization of Deuterium-Doped Gallium Antimonide Grown on Silicon Substrates" (2014). *UVM Honors College Senior Theses*. 5.
<https://scholarworks.uvm.edu/hcoltheses/5>

This Honors College Thesis is brought to you for free and open access by the Undergraduate Theses at ScholarWorks @ UVM. It has been accepted for inclusion in UVM Honors College Senior Theses by an authorized administrator of ScholarWorks @ UVM. For more information, please contact donna.omalley@uvm.edu.

Electrical Characterization of Deuterium-Doped Gallium Antimonide Grown on
Silicon Substrates

Justin Dao

Honors Thesis

Electrical Engineering

University of Vermont

Advisor: Professor Walter Varhue, Electrical Engineering

Abstract

In the world today, there exists the need for advances in high speed, energy efficient electronic applications. In the fields of lasers, transistors, and thermophotovoltaic systems, one potential improvement that is currently being explored is the use of gallium antimonide (GaSb), a III-V semiconducting material that has interesting electrical properties. GaSb is a material to be considered because it has a direct band gap of 0.726eV, as well as a relatively high electron mobility ($\leq 3000 \text{ cm}^2 \text{ V}^{-1} \text{ s}^{-1}$), which makes its use possible in high speed electronic applications [1]. In this research, GaSb will be grown as a thin-film on Si substrates because the cost of pure GaSb substrates is very high relative to that of Si [2].

Although GaSb has a high electron mobility, there exists a native defect in its lattice, causing the material to be intrinsically *p*-type. Prior research has suggested that doping GaSb with deuterium, an isotope of hydrogen, would correct this defect [3,4]. In a 2006 study performed by Tim Fennessey at the University of Vermont, the passivation of this defect was investigated using van der Pauw Hall measurements. In Fennessey's research, it was believed that with the addition of hydrogen, samples of GaSb would change from intrinsically *p*-type to *n*-type. Although several samples displayed a change in intrinsic carrier type, some did not, and the results were inconclusive. In an effort to clarify the results, this supplemental research seeks to resolve the effects of deuterium on thin-film GaSb devices in order to gain a more comprehensive understanding of semiconducting materials as a whole.

Table of Contents:

1. Introduction.....	(4-13)
Lattice structure	2
Native Defect.....	4
Sample Acquisition.....	6
Hall Effect.....	6
Van der Pauw Method.....	7
Resistivity Measurement.....	8
Hall Measurement.....	9
Apparatus.....	10
Temperature Effects.....	11
2. Results.....	(14-17)
Effect of Hydrogen.....	14
Effect of Deuterium.....	16
3. Discussion.....	18
4. Conclusion.....	19
5. References.....	20

Introduction:

Lattice Structure:

In modern electronics, silicon is the predominant semiconducting material used due to its diamond crystal lattice structure, low band gap of 1.11 eV, and widespread availability throughout the world [5]. A diamond crystal lattice is exceptionally strong, and can be seen as a combination of two face-centered cubic (FCC) lattices, shown in Figure 1.

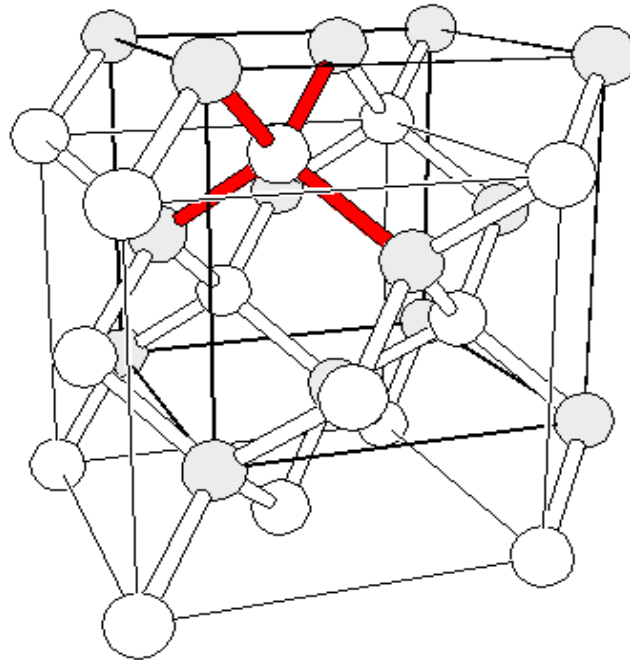

Figure 1. Diamond lattice, seen as a combination of two FCC lattices [6].

In comparison to silicon, gallium antimonide is a III-V compound semiconducting material with an even smaller band gap of 0.726eV, and forms as a variation of the diamond lattice structure called a zinc-blende structure [7]. A zinc-blende structure is characteristically

similar to a diamond lattice structure, however, alternating atoms are composed of different elements. A zinc-blende structure can be seen in Figure 2.

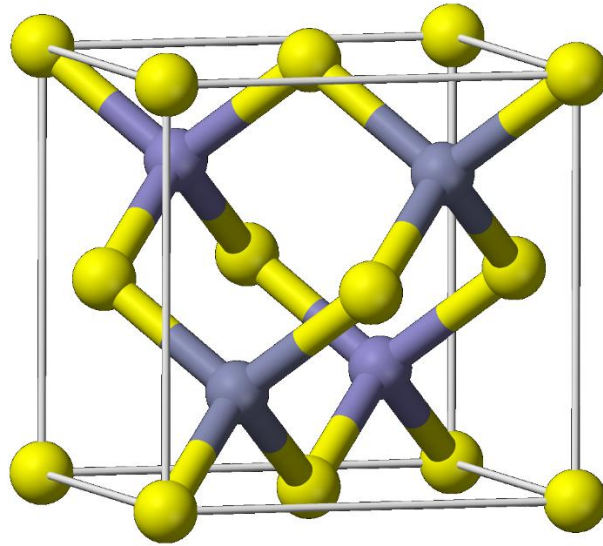

Figure 2. Zinc-blende structure of GaSb [7].

Native Defect:

According to prior research, undoped GaSb has been determined to be intrinsically *p*-type, with an average hole concentration of 10^{17} cm^{-3} and an average resistivity of $10^{-2} \Omega \text{ cm}$ [8].

The *p*-type characteristic has been attributed to a native defect in the lattice [8]. Native defects in the lattice act as trap sites for electrons, which influences the material's intrinsic carrier concentration. The source of the defect is understood to be a gallium atom, which has taken the place of antimony atom in the crystal lattice. To correct this defect, it has been suggested that if hydrogen or deuterium (a stable isotope of hydrogen) were to be added during the thin-film growth process, the defect would be passivated, reducing the intrinsic carrier concentration and increasing mobility [3,4].

Sample Acquisition:

To prepare samples to be examined, thin-film GaSb was grown on Si substrates. This process is detailed in both Tim Fennessey's thesis, titled, "Effect of Hydrogen Passivation on Heteroepitaxial Gallium Antimonide Grown on Silicon and Versulite Substrates," [2], as well as Thang Nguyen's dissertation, titled, "Growth of GaSb on a Variety of Substrates" [9]. Small, 8x8 mm square samples were cut, and aluminum was evaporated onto each of the four corners. If contacts were scratched, as many were, a small indium dot was melted on the center of each aluminum pad to facilitate probe contact. Indium was used because it creates an Ohmic contact with the material, which allows an increase in current to stimulate a directly proportional increase in voltage [5]. The methodology of the experiment will be explained in detail in an upcoming section.

Hall Effect:

The Hall effect is a phenomenon observed when current travelling in one direction is subject to a magnetic field applied in a perpendicular direction. As current travels through the conducting material on the positive x-axis, it experiences two forces: one force in the direction of motion (along the x-axis), as well as a force induced by the magnetic field (z-axis). As a result, carriers will tend to drift along the y-axis, depending on carrier type. Electrons will drift in a manner consistent with the right hand rule, while holes will drift in the opposite direction. Excess surface charge caused by the drifting of carriers induces a voltage across the y-axis called the Hall voltage. As an intrinsically p-type material, a diagram for the Hall effect in GaSb can be seen in Figure 3.

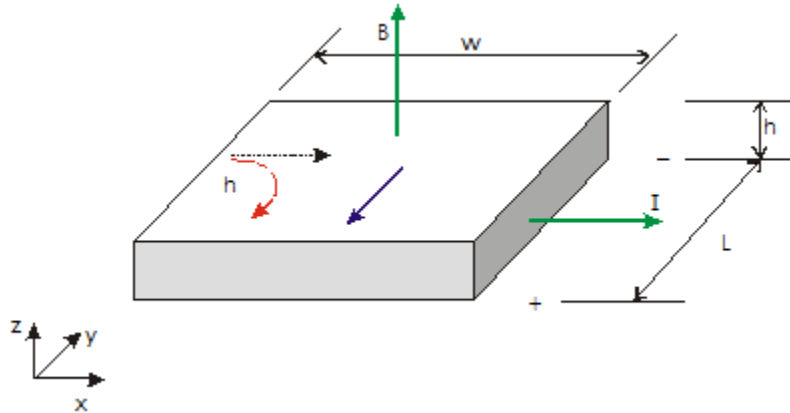

Figure 3. Hall effect diagram, with magnetic field vector B , constant current I , and material dimensions L , w , and h [10].

In this experiment, we will use the Hall voltage to determine sheet resistance, carrier density, carrier type, and eventually the Hall mobility, which determines the overall effectiveness of the semiconductor material.

Van der Pauw Method:

In order to determine the mobility of a material, the van der Pauw method is used, named after Leo J. van der Pauw, who discovered the technique in 1958 [11]. The technique entails calculating sheet density n_s from the Hall voltage V_H , as well as sheet resistance R_s in order to determine Hall mobility μ . A resistivity measurement must be performed in order to obtain R_s , while a Hall measurement must be performed to obtain n_s . This procedure is outlined in the Hall Effect section of the National Institute of Standards and Technology [12], and will be briefly explained in this section.

Resistivity Measurement:

For each sample, the four corner contacts are numbered from 1 to 4, going counterclockwise. To define nomenclature, if current was applied into contact 1 and out of contact 2, and voltage was measured from contact 4 to contact 3, the values would be written as I_{12} and V_{43} , respectively. To calculate the material's sheet resistance, a series of voltage measurements are made in response to the application of a DC current. For the first measurement, current is applied as I_{21} , and the resultant voltage V_{43} is measured. In order to minimize confounding results influenced by contact quality, sample shape, temperature, and photovoltaic effects, the current is then reversed (I_{12}), and the voltage is measured in the opposite orientation (V_{34}). Further measurements are made in an organized fashion, going counterclockwise around the sample ($V_{34}, V_{41}, V_{12}, V_{23}$) until all eight possible orientations are measured. Van der Pauw discovered that there are two separate characteristic resistances, R_A and R_B , associated with each sample, which is shown in Figure 4.

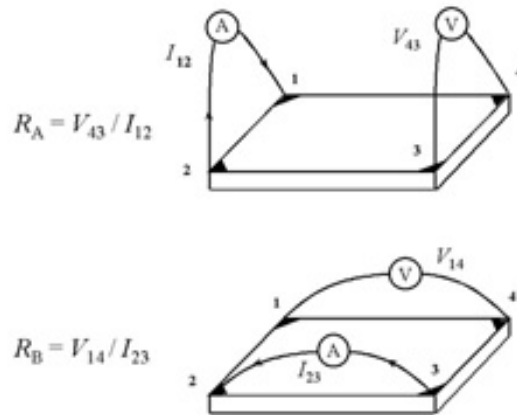

Figure 4. Two resistivity measurements required to calculate sheet resistance R_s [12].

The resistivities R_A and R_B are related through the following equation, which must be solved numerically for R_S :

$$\exp\left(-\frac{nR_A}{R_S}\right) + \exp\left(-\frac{nR_B}{R_S}\right) = 1$$

Hall Measurement:

Once the sheet resistance is known, one must also calculate the sheet density n_s using the van der Pauw Hall measurement. The sample is placed under a magnet of strength +4500 Gauss and cross-sample measurements are made (I_{13} & V_{24} , I_{42} & V_{13}) as well as each reverse measurement. The magnetic field polarity is then flipped (-4500 Gauss), and the same measurements are taken. Sheet density can then be calculated using the following equation:

$$V_H = \sum V_i = [(V_{24}^+ - V_{24}^-) + (V_{42}^+ - V_{42}^-) + (V_{13}^+ - V_{13}^-) + (V_{31}^+ - V_{31}^-)]$$

where V_{24}^+ is the Hall voltage across contact 2 to 4 with the positive magnetic field. With this value, one may then calculate n_s , using the following:

$$n_s = \frac{IB}{q|V_H|}$$

where I is current in Amperes, B is the magnetic field strength in Gauss, and q is the fundamental charge (1.602×10^{-19}) in Coulombs. With values for both n_s and R_S , the Hall mobility may be calculated using the equation:

$$\mu = \frac{|V_H|}{R_S IB} = \frac{1}{(qn_s R_S)}$$

The intrinsic carrier type depends on the sign of V_H ; if V_H is negative, the material was measured to be n -type, and if V_H is positive, the material was measured to be p -type.

Apparatus

Measurements made in this research will be performed in a special probe station, which contains four probes connected to a switching box, Keithley 220 programmable current source, Keithley 195A digital multimeter, and 100x gain operational amplifier. The overall mechanism can be seen in Figure 5.

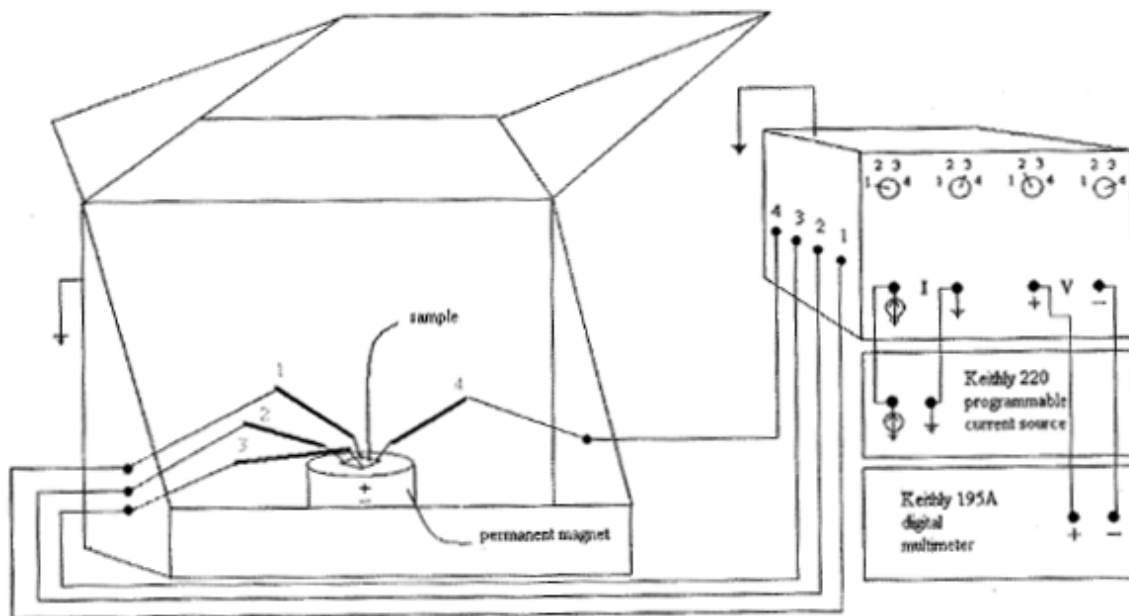

Figure 5. Probe station and configuration [2].

In this setup, because a 100x gain operational amplifier is used, a dark box encloses the probe station to minimize the influence of exterior light. The switching box allows for more efficient probe switching, and can be seen in Figure 6.

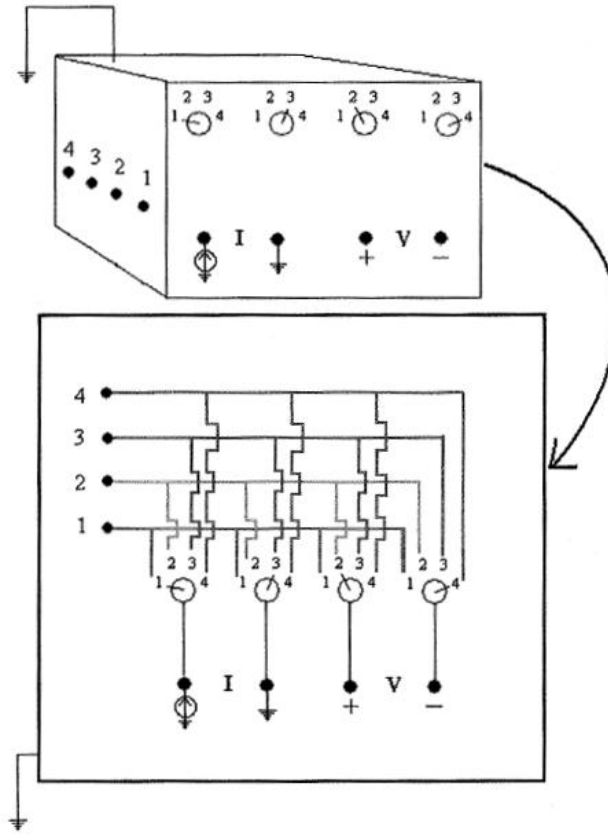

Figure 6. Switching box.

Temperature Effects:

In Tim Fennessey's prior research [2], some samples grown with hydrogen did not exhibit either a change in carrier type or an increase in mobility. Because of humid laboratory conditions and warm temperatures during experiments, it was initially believed that temperature was a factor that potentially negated hydrogen's effect on GaSb. This is because in a direct bandgap semiconductor, electrons do not require a change in momentum in order to jump from

the valence band to the conduction band; the only requirement is sufficient energy. An example of a direct bandgap E-K diagram can be seen in Figure 7.

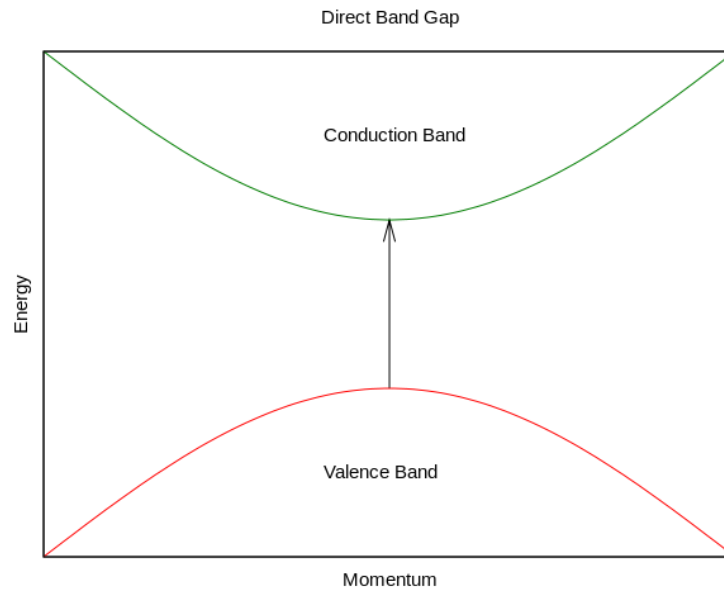

Figure 7. E-K diagram for a direct bandgap semiconductor [13].

Because the only requirement is sufficient energy, it was believed that warmer temperatures stimulated phonon scattering effects, exciting electrons and complicating experimental results. To remedy these temperature dependences, the original intention was to measure the Hall mobility while the sample was exposed to liquid nitrogen, at 77K. A study performed by G.R. Johnson et al. [14] in 1988 observed mobility characteristics of GaSb, as they were subject to varying temperatures from near 0K to 400K for both holes and electrons. The results are shown in Figure 8.

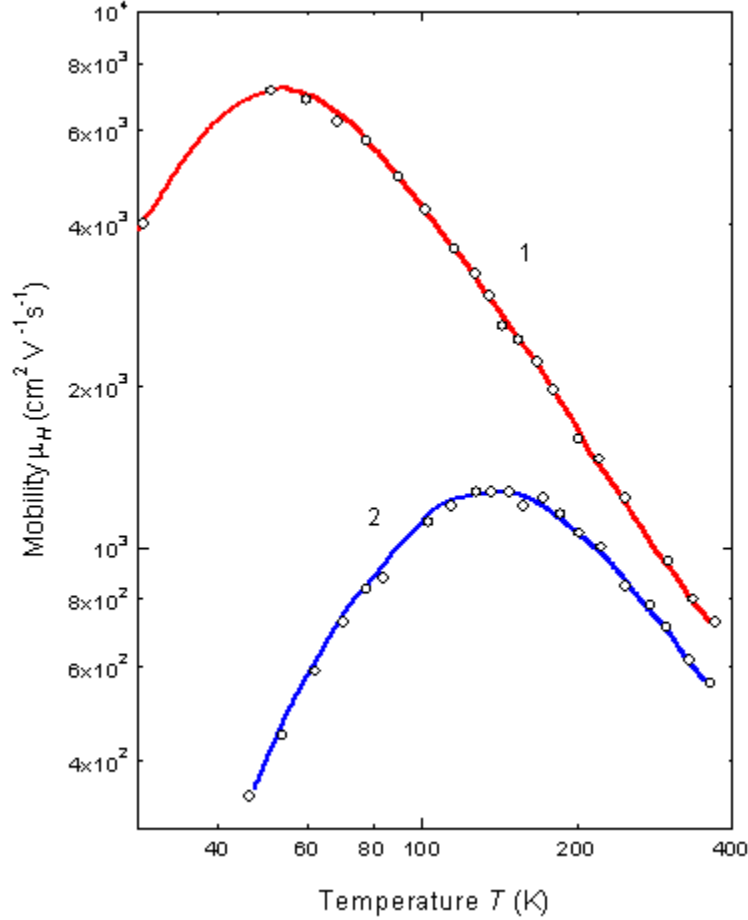

Figure 8. Temperature vs Mobility for GaSb, for both electrons (1) and holes (2). [14]

The results from Johnson et al. suggest that the mobility values for GaSb are uninfluenced by slight variations in experimental temperature conditions. Furthermore, for GaSb holes, as temperature decreases from 300K, mobility increases to a peak value of roughly $1.3 \times 10^3 \text{ cm}^2 \text{ V}^{-1} \text{ s}^{-1}$ at 140K, and decreases again at liquid nitrogen temperatures. These results nullify the hypothesis that phonon scattering effects disturb hydrogen passivation of intrinsic GaSb impurities. Measurements made in this research will be done at room temperature, 300K.

Results:

Each data sample was measured three separate times in three separate years: once in 2006 by Tim Fennessey, once in 2013 by Richard Smith III, a graduate student at the University of Vermont, and once for the purposes of this research. All three results will be listed in this section as #1, #2, and #3 respectively, in order to explore similarities and differences between them.

Effect of Hydrogen:

The effect of hydrogen added during the growth process of GaSb was first explored. Samples 052A and 075A were grown side by side with 052A serving as a standard run (STD) control sample, while 075A was exposed to hydrogen in the growth process. Both were grown in the (100) orientation with similar crystal quality. The same process was repeated with samples 124B and 075B, grown in the (111) orientation, with 124B serving as the control sample. The results can be seen in Table 1 below.

Sample	Orientation	Run Type	Crystallinity (deg)	Mobility (cm^2 / Vs)		
				Concentration (cm^{-3})		
				Resistivity (Ωcm)		
				#1	#2	#3
TFGaSb052A	100	STD, 1 hr.	0.52	76	87.17	55.99
				4.66E+19	6.82E+019	2.21E+018
				1.80E-03	1.05E-03	5.06E-02
TFGaSb075A	100	H2, 1 hr.	0.55	-183	-38.84	-36.84
				-6.50E+18	-2.38E+019	-2.96E+019
				5.30E-03	6.77E-03	4.71E-03
TFGaSb124B	111	STD, 1 hr.	0.2418	49	54.45	53.21
				7.94E+018	5.61E+018	1.10E+017
				1.62E-02	2.04E-02	1.92E-01
TFGaSb075B	111	H2, 1 hr.	0.43	20	28.17	29.53
				2.15E+19	1.31E+019	1.24E+018
				1.46E-02	1.70E-02	1.71E-01

Table 1. Effect of hydrogen on Hall mobility, concentration, and resistivity.

For the (100) orientation, sample 052A was measured to have a p -type mobility of roughly $70 \text{ cm}^2/\text{Vs}$, which is characteristic for intrinsic GaSb materials. As for sample 075A, it appears the intrinsic carrier type has changed from p -type to n -type, with a mobility value of around $-37 \text{ cm}^2/\text{Vs}$. For the (111) orientation, contrary to the hypothesis, it appears that the introduction of hydrogen only lowered the mobility, rather than change the carrier type. One possible explanation is that hydrogen was not fully incorporated into the thin film during the growth process. To ensure the effect of hydrogen passivation of native GaSb defects, deuterium will be introduced during the growth process, rather than hydrogen. Although deuterium has greater mass, it behaves in a manner identical to hydrogen, and its incorporation into the thin film can more easily be identified via mass spectroscopy techniques.

Effect of Deuterium:

The same process as before was repeated, however deuterium was introduced into the vacuum chamber instead of hydrogen. Two samples 125A and 127B were created, grown in the (100) orientation, while two other samples 125B and 127A were created, grown in the (111) orientation. The results can be seen in Table 2.

Sample	Orientation	Run Type	Crystallinity (deg)	Mobility (cm^2 / Vs)		
				Concentration (cm^{-3})		
				Resistivity (Ωcm)		
				#1	#2	#3
TFGaSb125A	100	D2, 64min	0.524	-1098	-776.8	-1163
				-7.31E+017	-1.60E+018	-7.20E+016
				7.80E-03	7.56E-03	7.47E-02
TFGaSb127B	100	D2, 1Hr	0.368	-847	-914.8	-686.5
				-1.30E+018	-1.25E+018	-1.61E+018
				5.70E-03	5.45E-03	5.65E-03
TFGaSb125B	111	D2, 64min	0.0523	-37	-43.68	-43.78
				-2.30E+018	-1.96E+018	-1.91E-018
				7.28E-02	7.29E-02	7.11E-02
TFGaSb127A	111	D2, 1Hr	0.0686	-161	-144	-141.2
				-1.49E+018	-2.96E+017	-2.96E+017
				1.42E-01	1.47E-01	1.49E-01

Table 2. Effect of deuterium on Hall mobility, concentration, and resistivity.

Each sample exposed to deuterium in the growth process have *n*-type mobilities, ranging from about $-40 \text{ cm}^2/Vs$ to roughly $-1000 \text{ cm}^2/Vs$. It is an interesting observation to make that samples grown in the (100) orientation appear to be heavily affected by the addition of deuterium, as their mobilities are much higher and resistivities are much lower than that of the samples grown in the (111) orientation. It also seems apparent that higher crystallinity leads to higher mobility, as the sample with the highest crystallinity of 0.524 degrees (125A) has the

greatest mobility, whereas the sample with the lowest crystallinity of 0.0686 degrees (127A) has the lowest mobility. This is to be expected, because electrons can more easily move through a material with higher crystalline structure than one without.

Discussion:

It is apparent that the addition of hydrogen and deuterium affects electrical characteristics of GaSb thin film materials, namely the intrinsic carrier type and the Hall mobility. With the addition of hydrogen into the vacuum chamber, it appears that the sample grown in the (100) orientation displayed a change from a *p*-type mobility of about $70 \text{ cm}^2/\text{Vs}$, to an *n*-type mobility of about $-37 \text{ cm}^2/\text{Vs}$. While the (100) orientation samples acted as expected, the (111) orientation samples did not, as the standard process sample had a *p*-type mobility of roughly $50 \text{ cm}^2/\text{Vs}$, while the hydrogen sample also had a *p*-type mobility of $30 \text{ cm}^2/\text{Vs}$. It is possible that hydrogen was not well incorporated into the thin film GaSb during the growth process; as a result, deuterium was added to further clarify results.

With the addition of deuterium, four samples were created. Two samples were grown for each of the (100) and (111) orientations. It was found during testing that each of the four samples exhibited a change in intrinsic carrier type, with mobilities ranging from $-40 \text{ cm}^2/\text{Vs}$ to $-1100 \text{ cm}^2/\text{Vs}$. This evidence was confirmed by three separate tests for each sample: the greatest percent error between the lowest and highest mobility values was roughly 18% for sample 127B, with each test citing *n*-type mobilities.

A trend could also be seen that greater crystallinity values resulted in greater mobility values. The sample with the highest crystallinity of 0.524 degrees (125A) has the greatest mobility, whereas the sample with the lowest crystallinity of 0.0686 degrees (127A) has the lowest mobility.

Conclusion:

In conclusion, the combination of test results from three separate experiments have strongly suggested that the electrical characteristics of GaSb are influenced by the addition of hydrogen and deuterium during the thin film growth process, which has been suggested in prior studies [3,4]. It was found that under the influence of hydrogen and deuterium, thin film GaSb materials changed from being intrinsically *p*-type to *n*-type. This is an interesting result, and will give further insight into the alternatives of semiconductor materials.

References:

- [1] Physico-Technical Institute of the Ioffe. *Gallium Antimonide Band Structure and Carrier Concentration*. Russia. <http://www.ioffe.ru/SVA/NSM/Semicond/GaSb/bandstr.html>
- [2] Fennessey, Tim. *The Effect of Hydrogen Passivation on Heteroepitaxial Gallium Antimonide Grown on Silicon and Versulite Substrates*. M.S Thesis, University of Vermont, Electrical Engineering Dept. (2006)
- [3] Polyakov, A.Y, Pearton, S.J., Wilson, R.G. *Hydrogen Effect on Shallow and Deep Centers in GaSb*. Appl. Phys Lett. **60**,11. (1992)
- [4] Stephanek, B., Sestak, J., Mares, J.J., Kristofik, J., Setsakova, V., Hubik, P. *Intelligent Design of GaSb Doped Single Crystals*. Institute of Electronics and Electrical Engineers. (1999)
- [5] Neamen, Donald A. *Semiconductor Physics and Devices, 4th Edition*. McGraw Hill. (2011)
- [6] Hermann, K. *Diamond Lattice*. Theory Department, Fritz-Hauber Institute, Berlin. <http://www.fhi-berlin.mpg.de/~hermann/Balsac/BalsacPictures/diamondlat.gif>
- [7] *Effects of Multidimensional Defects on III-V Semiconductor Mechanics*. Material Science and Engineering, Massachusetts Institute of Technology Open Courseware.
- [8] Van Der Muelen, Y.J. *Growth Properties of GaSb: The Structure of the Residual Acceptor Centres*. Journal of Physics and Chemistry of Solids, **28**, 25. (1967)
- [9] Nguyen, T. *Growth of GaSb on a Variety of Substrate Materials*. Ph.D. Dissertation, University of Vermont, Electrical Engineering Dept. (2004)
- [10] University of California at Berkeley, Donald A. Glaser Advanced Experimentation Laboratory. *Hall Effect*. <http://www.advancedlab.org/mediawiki/images/1/11/SHEimage028.gif>
- [11] Van der Pauw, L.J. *A Method of Measuring Specific Resistivity and Hall Effect of Discs of Arbitrary Shape* (PDF). *Philips Research Reports* **13**: 1–9. (1958).

- [12] National Institute of Standards and Technology Physical Measurement Laboratory. *Resistivity and Hall Measurements*. http://www.nist.gov/pml/div683/hall_resistivity.cfm
direct band gap <http://en.wikipedia.org/wiki/File:Direct.svg>
- [13] Wikipedia Commons. *Direct and Indirect Band Gaps*. Accessed 4-2-14.
- [14] Johnson, G. R., B. C. Cavenett, and T. M. Kerr, *Semicond. Sci. Technol.* **3**, 1157-1165 (1988).